

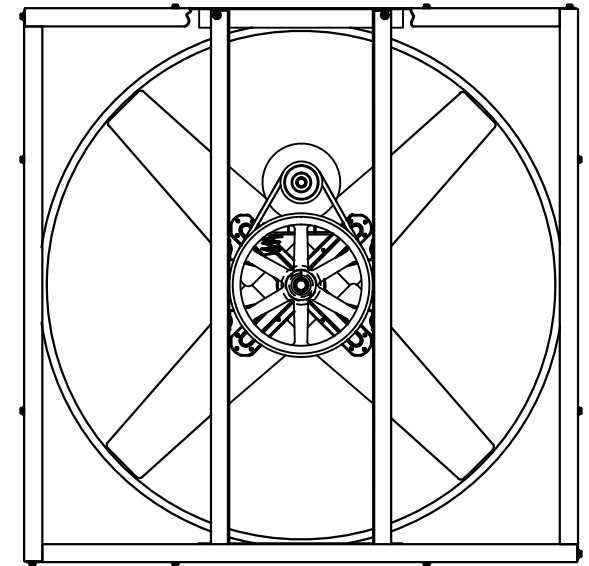

INTAKE VIEW

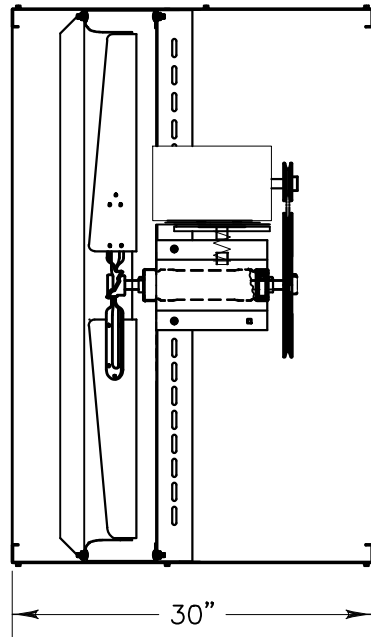

DISCHARGE VIEW

HORSE POWER: 3/4  
 VOLTAGE: 230/460V  
 PHASE: 3  
 BLADE DIAMETER: 42"

 TRIANGLE ENGINEERING OF ARKANSAS, INC.	RV14214X WALL FAN	
	RV14214X	REV
DR. BY: TOM KING	CKD.	APP.
SHEET 1 OF 1	NOT TO SCALE	6 OCT 2015