

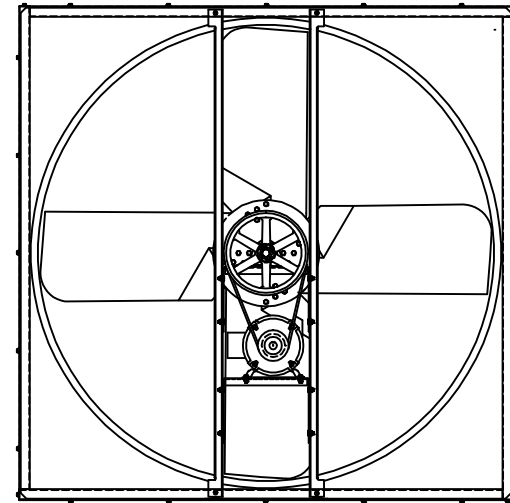

DISCHARGE VIEW

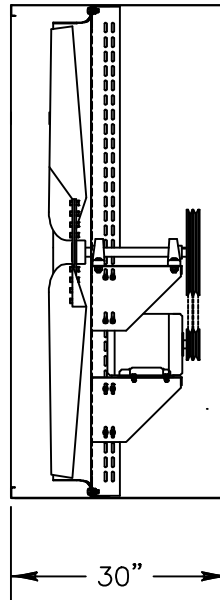

INTAKE VIEW

TRIANGLE ENGINEERING CERTIFIED DRAWING	
BY:	
FOR:	
DATE:	
VI6019 WALL FAN, 5 HP 230/460 V. 3 PHASE	
BLADE DIA 60"	

ALL DIMENSIONS IN INCHES
ALL DIMENSIONS $\pm \frac{1}{4}$ "

 TRIANGLE ENGINEERING OF ARKANSAS, INC.	VI6019 WALL FAN	
	L-VI6019	REV
DR. BY: TOM KING	CKD.	APP.
SHEET 1 OF 1	NOT TO SCALE	10 DEC 2003