



OPERATOR MANUAL

MODELS: 95CMP & 95CMPED



CONCRETE MIXER

A 100% employee-owned American manufacturer

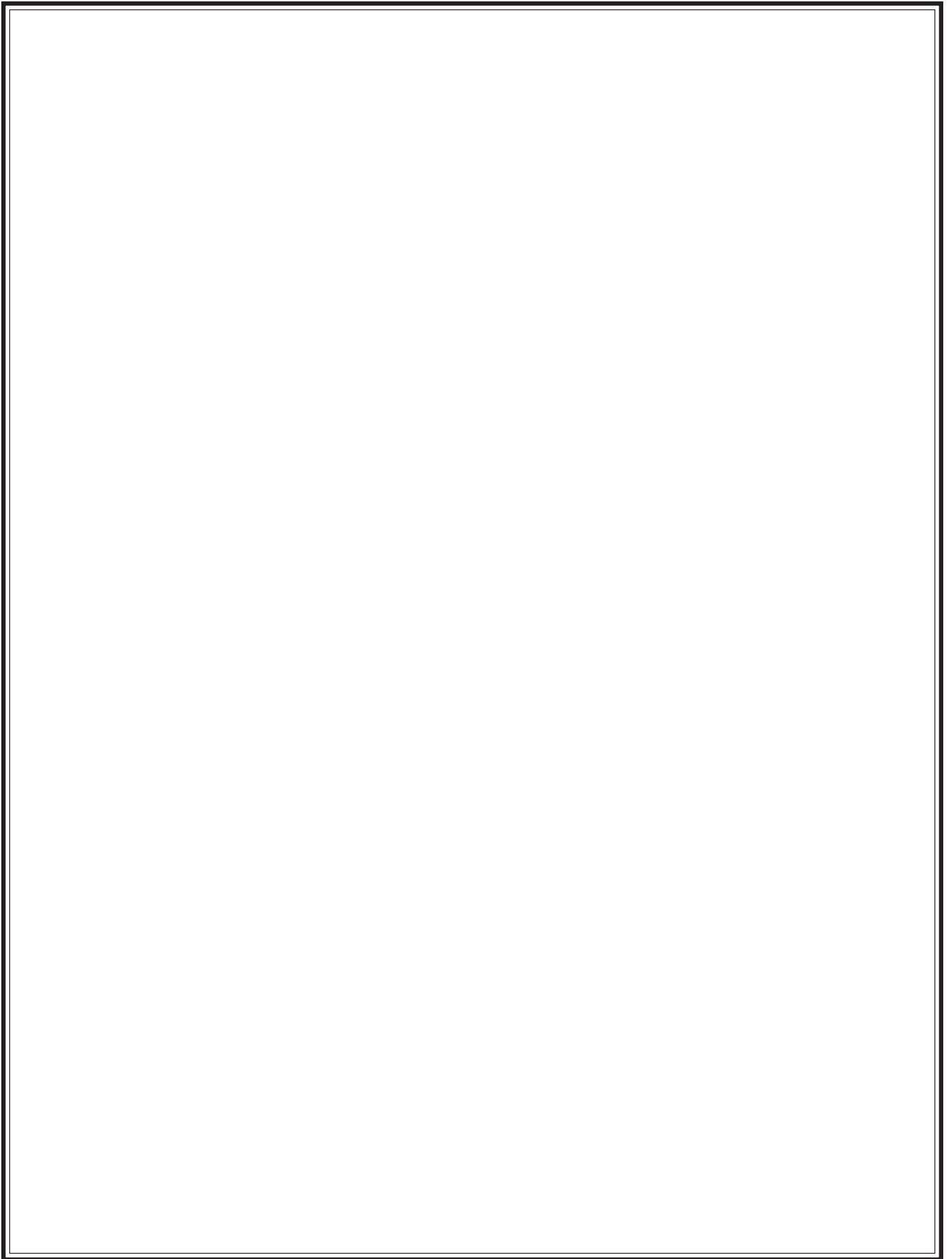

Table of Contents

95CMP & 95CMPED

FOREWORD	4
LIMITED WARRANTY	5
TECHNICAL DATA	6 - 8
Specifications	6
Imperial Torque Chart	7
Metric Torque Chart	8
HEALTH & SAFETY	9 - 13
OPERATIONS	14 - 18
Before Starting	14
Safety Chain Installation	14
Oil Levels and Lubrication	14
Hardware	14
Fuel	14
To Start the Engine/Motor	14 - 15
To Stop The Engine/Motor	15
Operation	15
Capacities	16
Sample Mix/Coupler Maintenance	16
Towing	16 - 17
Maintenance Schedule	18
CALIFORNIA PROPOSITION 65 WARNING	19

User Information

Foreword

These instructions include:

- Safety regulations
- Operating instructions
- Maintenance instructions

These instructions have been prepared for operation on the construction site and for the maintenance engineer.

These instructions are intended to simplify operation of the machine and to avoid malfunctions through improper operation.

Observing the maintenance instructions will increase the reliability and service life of the machine when used on the construction site and reduce repair costs and downtimes.

Always keep these instructions at the place of use of the machine.

Only operate the machine as instructed and follow these instructions.

Observe the safety regulations as well as the guidelines of the civil engineering trade association. Observe the safety rules for operation and the pertinent regulations for the prevention of accidents.

Stone Construction Equipment, Inc. is not liable for the function of the machine when used in an improper manner or for other than the intended purpose.

Operating errors, improper maintenance and the use of incorrect operating materials are not covered by the warranty.

The above information does not extend the warranty and liability conditions of business of Stone Construction Equipment, Inc.

1. Machine Type: _____

Machine S/N: _____

2. Engine Type: _____

Engine S/N: _____

3. VIN: _____

4. Purchase Date: _____

5. Dealer/Distributor Information:

Name: _____

Address: _____

Phone #: _____

Fax #: _____

6. Battery
Manufacturer: _____

Battery Type: _____

Battery S/N: _____

Location of above information:

1. Information on S/N tag.
2. Information on engine tag.
3. Information on S/N tag - if applicable.
4. Date you purchased machine.
5. Dealer machine was purchased from.
6. Information on battery and battery warranty card.

Stone Construction Equipment, Inc.
P.O. Box 150, Honeoye, New York 14471
Phone: (800) 888-9926
Fax: (585) 229-2363

L i m i t e d W a r r a n t y

The Manufacturer warrants that products manufactured shall be free from defects in material and workmanship that develop under normal use for a period of 90 days for concrete vibrators and electric pumps, one year for Rhino®, Bulldog®, WolfPac Rollers™, trowels, Stompers®, saws, forward plates, engine powered pumps, Lift Jockey™, Mortar Buggy™ and 6 months for all other products from the date of shipment. The foregoing shall be the exclusive remedy of the buyer and the exclusive liability of the Manufacturer. Our warranty excludes normal replaceable wear items, i.e. gaskets, wear plates, seals, O-rings, V-belts, drive chains, clutches, etc. Any equipment, part or product which is furnished by the Manufacturer but manufactured by another, bears only the warranty given by such other manufacturer. (The Manufacturer extends the warranty period to "Lifetime" for the drum bearings and seals for the mortar mixers, and agrees to furnish, free of charge, the bearings and seals only upon receipt of the defective parts. The warranty is two years for eccentric bearings on the forward plate compactors, mortar and plaster mixer drums, trowel gearboxes and five years on the Bulldog trench roller eccentric bearings.) A Warranty Evaluation Form must accompany all defective parts. Warranty is voided by product abuse, alterations, and use of equipment in applications for which it was not intended, use of non-manufacturer parts, or failure to follow documented service instructions. The foregoing warranty is exclusive of all other warranties whether written or oral, expressed or implied. No warranty of merchantability or fitness for a particular purpose shall apply. The agents, dealer and employees of Manufacturer are not authorized to make modification to this warranty, or additional warranties binding on Manufacturer. Therefore, additional statements, whether oral or written, do not constitute warranty and should not be relied upon.

The Manufacturer's sole responsibility for any breach of the foregoing provision of this contract, with respect to any product or part not conforming to the Warranty or the description herein contained, is at its option (a) to repair, replace or refund such product or parts upon the prepaid return thereof to location designated specifically by the Manufacturer. Product returns not shipped prepaid or on an economical transportation basis will be refused (b) as an alternative to the foregoing modes of settlement - the Manufacturer's dealer to repair defective units with reimbursement for expenses, except labor, and be reviewed with the Manufacturer prior to repair. A Warranty Evaluation Form must accompany all warranty claims.

Except as set forth hereinabove and without limitation of the above, there are no warranties or other affirmations which extends beyond the description of the products and the fact hereof, or as to operational efficiency, product reliability or maintainability or compatibility with products furnished by others. In no event whether as a result of breach of contract or warranty or alleged negligence, shall the Manufacturer be liable for special or consequential damages including but not limited to: Loss of profits or revenues, loss of use of the product or any associated product, cost of capital, cost of substitute products, facilities or services or claims of customers.

No claim will be allowed for products lost or damaged in transit. Such claims should be filed with the carrier within fifteen days.

Effective July 2002.

Stone Construction Equipment, Inc. • 8662 Main Street, P. O. Box 150 • Honeoye, NY 14471-0150
Phone: 1-800-888-9926 • 1-585-229-5141 Fax: 1-585-229-2363
www.stone-equip.com • e-mail: sceny@stone-equip.com

TECHNICAL DATA

Specifications

Stone 95CMP & 95CMPED Mixer – Specifications

	95CMP	95CMPED
<u>Dimensions</u>		
Operating Wt.	837 lbs. (w/ 8 hp Honda) 380 kg	875 lbs. (w/ 8 hp Honda) 396.9 kg
Batch Capacity (Bags)	1 - 1 1/2 bags	1 - 1 1/2 bags
Batch Capacity (cu. ft.)	9 cu. ft. / .255 cu. m.	9 cu. ft. / .255 cu. m.
Total Volume	15.1 cu. ft. / .43 cu. m.	15.1 cu. ft. / .43 cu. m.
L x W x H	84 x 56 x 65 (in) 213.4 x 142.2 x 165.1 (cm)	85 x 85 x 71 (in) 215.9 x 215.9 x 180.3 (cm)
Power Source	1 1/2 hp / 1.1 kW Electric 6 hp / 4.5 kW Diesel 8.5 hp / 6.3 kW Robin 8 hp / 6 kW B&S Kool Bore 8 hp / 5.9 kW B&S I/P 8 hp / 6 kW Honda 10 hp / 7.5 kW B&S I/P	1 1/2 hp / 1.1 kW Electric 6 hp / 4.5 kW Diesel 8.5 hp / 6.3 kW Robin 8 hp / 6 kW B&S Kool Bore 8 hp / 5.9 kW B&S I/P 8 hp / 6 kW Honda 10 hp / 7.5 kW B&S I/P

TECHNICAL DATA

Imperial Torque Chart

SAE GRADE 5 Coarse Thread, Zinc-Plated		
SIZE	TORQUE	
	ft. lbs.	Nm
1/4 - 20 (.250)	6	8
5/16 - 18 (.3125)	13	18
3/8 - 16 (.375)	23	31
7/16 - 14 (.4375)	37	50
1/2 - 13 (.500)	57	77
9/16 - 12 (.5625)	82	111
5/8 - 11 (.625)	112	152
3/4 - 10 (.750)	200	271
7/8 - 9 (.875)	322	436.5
1 - 8 (1.000)	483	655

SAE GRADE 8 Coarse Thread, Zinc-Plated		
SIZE	TORQUE	
	ft. lbs.	Nm
1/4 - 20 (.250)	9	12
5/16 - 18 (.3125)	18	24
3/8 - 16 (.375)	33	45
7/16 - 14 (.4375)	52	70
1/2 - 13 (.500)	80	108
9/16 - 12 (.5625)	115	156
5/8 - 11 (.625)	159	215
3/4 - 10 (.750)	282	382
7/8 - 9 (.875)	454	615
1 - 8 (1.000)	682	925

SAE GRADE 5 Fine Thread, Zinc-Plated		
SIZE	TORQUE	
	ft. lbs.	Nm
1/4 - 28 (.250)	7	10
5/16 - 24 (.3125)	14	19
3/8 - 24 (.375)	26	35
7/16 - 20 (.4375)	41	56
1/2 - 20 (.500)	64	87
9/16 - 18 (.5625)	91	123
5/8 - 18 (.625)	128	173
3/4 - 16 (.750)	223	302
7/8 - 14 (.875)	355	481
1 - 12 (1.000)	529	717
1 - 14 (1.000)	541	733

SAE GRADE 8 Fine Thread, Zinc-Plated		
SIZE	TORQUE	
	ft. lbs.	Nm
1/4 - 28 (.250)	10	14
5/16 - 24 (.3125)	20	27
3/8 - 24 (.375)	37	50
7/16 - 20 (.4375)	58	79
1/2 - 20 (.500)	90	122
9/16 - 18 (.5625)	129	175
5/8 - 18 (.625)	180	244
3/4 - 16 (.750)	315	427
7/8 - 9 (.875)	501	679
1 - 12 (1.000)	746	1011
1 - 14 (1.000)	764	1036

t-chrt_i.doc

TECHNICAL DATA

Metric Torque Chart

Property Class 8.8

ZINC-PLATED

SIZE	Coarse Thread		Fine Thread	
	Nm	ft. lbs.	Nm	ft. lbs.
M6	9.9	7	NA	NA
M8	24	18	25	18
M10	48	35	49	36
M12	83	61	88	65
M14	132	97	140	103
M16	200	148	210	155
M20	390	288	425	313
M24	675	498	720	531

Property Class 10.9

ZINC-PLATED

SIZE	Coarse Thread		Fine Thread	
	Nm	ft. lbs.	Nm	ft. lbs.
M6	14	10	NA	NA
M8	34	25	35	26
M10	67	49	68	50
M12	117	86	125	92
M14	185	136	192	142
M16	285	210	295	218
M20	550	406	600	443
M24	950	701	1000	738

Property Class 12.9

ZINC-PLATED

SIZE	Coarse Thread		Fine Thread	
	Nm	ft. lbs.	Nm	ft. lbs.
M6	16.5	12	NA	NA
M8	40	30	42	31
M10	81	60	82	60
M12	140	103	150	111
M14	220	162	235	173
M16	340	251	350	258
M20	660	487	720	531
M24	1140	841	1200	885

Conversion Factor: 1 ft. lb. = 1.3558 Nm

HEALTH & SAFETY

Safety Precautions

Before using this equipment, study this entire manual to become familiar with its operation. Do not allow untrained or unauthorized personnel, especially children, to operate this equipment. Use only factory authorized parts for service.

When warning decals are destroyed or missing, contact the Manufacturer immediately at 1-800-888-9926 for replacement. For the safety of yourself and others, it is imperative that the following rules are observed. Failure to do so may result in serious injury or death.

FOLLOW SAFETY INSTRUCTIONS

Carefully read all safety messages and decals in this manual and on your machine safety signs. Keep decals in good condition. Replace missing or damaged decals. Be sure new equipment components and repair parts include the current safety signs. Replacement safety signs and decals are available through your dealer.



Learn how to operate the machine and how to use controls properly. Do not let anyone operate without instruction.

Keep your machine in proper working condition. Unauthorized modifications to the machine may impair the function and/or safety and affect machine life.

If you do not understand any part of this manual and need assistance, contact your dealer.

▲ DANGER

▲ WARNING

▲ CAUTION

UNDERSTAND SIGNAL WORDS

A signal word – DANGER, WARNING, or CAUTION – is used with the safety-alert symbol. DANGER identifies the most serious hazards.

DANGER or WARNING safety signs are located near specific hazards. General precautions are listed on CAUTION safety signs. CAUTION also calls attention to safety messages in this manual.



This notation appears before warnings in the text. It means that the step which follows must be carried out to avoid the possibility of personal injury or death. These warnings are intended to help the technician avoid any potential hazards encountered in the normal service procedures. We strongly recommend that the reader takes advantage of the information provided to prevent personal injury or injury to others.

HEALTH & SAFETY

Safety Precautions

USE COMMON SENSE WHEN HANDLING FUELS



- Transport and handle fuel only when contained in approved safety container.
- Do not smoke when refueling or during any other fuel handling operation.
- Do not refuel while the engine is running or while it is still hot.
- If fuel is spilled during refueling, wipe it off of the engine immediately and discard the rag in a safe place.
- Do not operate the equipment if fuel or oil leaks exist - repair immediately.
- Never operate this equipment in an explosive atmosphere.



- Always use the proper size grounded extension cord, conforming to the National Electric Code and Local Ordinances.
- Inspect all extensions and electrical cords for cuts, frayed wire and broken connectors before use. Do not use cords if not in good condition.
- Do not route extension cords through standing water.
- Do not operate the mixer in standing water.
- When cleaning the mixer, never spray water on the electric motor.



HOT SURFACES

- Avoid contact with hot exhaust systems and engines.
- Allow all components in the engine compartment to cool before performing any service work.

WARNING

- Never leave mixer unattended while running.
- Mix only concrete.

HEALTH & SAFETY

Safety Precautions

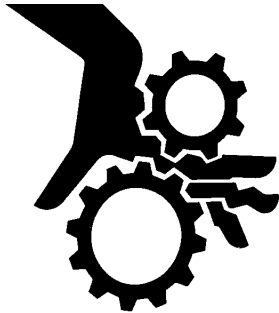

- Never perform any work on the mixer while it is running.
- Before working on the mixer, stop the engine and disconnect the spark plug wire(s) to prevent accidental starting. On electric models, disconnect the electric cord at the mixer.
- Keep cowl closed and latched during the operation, close and latch cowl immediately after starting.
- Keep hands, clothing and jewelry away from all moving parts.
- Keep all guards in place, including drum guards.
- Never place your hands or any solid object into the drum while the mixer is in operation.

WEAR PROTECTIVE CLOTHING

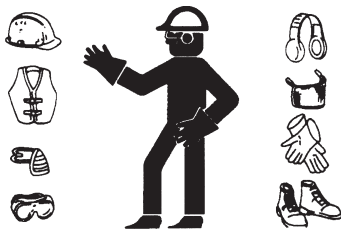

- Wear close fitting clothing and safety equipment appropriate to the job.
- Prolonged exposure to loud noise can cause impairment or loss of hearing.
- Wear a suitable hearing protective device such as earmuffs or earplugs to protect against objectionable or uncomfortable loud noises.
- Operating equipment safely requires the full attention of the operator. Do not wear radio or music headphones while operating machine.

PREPARE FOR EMERGENCIES

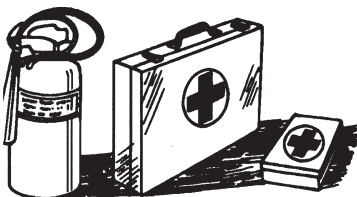

- Be prepared if a fire starts.
- Keep a first aid kit and fire extinguisher handy.
- Keep emergency numbers for doctors, ambulance service, hospital, and fire department near your telephone.



Warning-Eye Protection

- Always wear splash goggles when operating mixer.

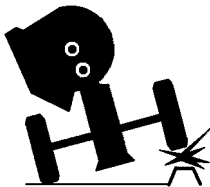

Warning-Towing

- Warning: Do not tow the mixer with the drum in the dump position. Mixer may become unstable and tip over when hitting a curb, pothole, or other obstruction.
- Warning: Always properly attach safety chains before mixer is towed. Maximum towing speed 55 m.p.h. (90 km/hr). Reduce speed according to highway conditions.



DANGER



**BEFORE
TOWING**

1. Check vehicle hitch, ball, and coupler for signs of wear or damage. Replace any parts that are worn or damaged before towing.
2. Use only the ball diameter indicated on your coupler. Use of any other ball diameter will create an extremely and dangerous condition which can result in separation of the coupler and ball or ball failure.
3. Be sure the coupler is secured to the hitch ball and the lock lever is down tight and locked. Assure that the ball clamp is properly nested under the ball and not sitting on top of the ball. Recheck tightness again after towing about 50 miles.
4. Check that trailer safety chains are properly connected.
5. Check that all trailer lighting is hooked up and working correctly.



- Never operate unit in a poorly ventilated or enclosed area.
- Avoid prolonged breathing of exhaust gases.
- Engine exhaust fumes can cause sickness or death.

HEALTH & SAFETY

Safety Precautions

PRACTICE SAFE MAINTENANCE



- Understand service procedure before doing work. Keep area clean and dry.
- Never lubricate, service or adjust machine while it is moving. Keep hands, feet, and clothing from power-driven parts. Disengage all power and operate controls to relieve pressure. Lower equipment to the ground. Stop the engine. Remove the key. Allow machine to cool.
- Securely support any machine elements that must be raised for service work.
- Keep all parts in good condition and properly installed. Repair damage immediately. Replace worn or broken parts. Remove any buildup of grease, oil, or debris.
- Disconnect battery ground cable (-) before making adjustments on electrical systems or welding on machine.



- Starting fluid (ether) is highly flammable, do not use or an explosion or fire may result.

DISPOSE OF WASTE PROPERLY

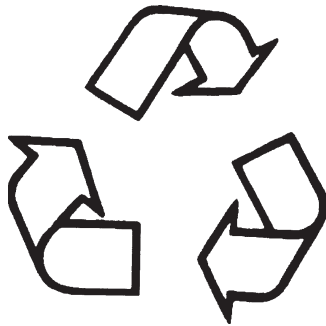

- Improperly disposing of waste can threaten the environment and ecology. Potentially harmful waste used with equipment include such items as oil, fuel, coolant, brake fluid, filters, and batteries.
- Use leakproof containers when draining fluids. Do not use food or beverage containers that may mislead someone into drinking from them.
- Do not pour waste onto the ground, down a drain, or into any water source.
- Air conditioning refrigerants escaping into the air can damage the Earth's atmosphere. Government regulations may require a certified air conditioning service center to recover and recycle used air conditioning refrigerants.
- Inquire on the proper way to recycle or dispose of waste from your local environmental or recycling center.

SAFETY DECALS - FOR THE SAFETY OF YOURSELF AND OTHERS REPLACE ANY DAMAGED OR MISSING SAFETY DECALS.

- Warning Decal (SN-92) P/N 55011
- Safety Instruction Decal (SN-67A) P/N 55046
- Warning Decal (SN-8) P/N 55127
- Safety Chain Decal (Front Post, SN-66) P/N 55121

OPERATION

95CMP & 95CMPED

BEFORE STARTING

Mixer are shipped completely assembled and ready for operation except for installation of the safety chain.

SAFETY CHAIN INSTALLATION - Remove the safety chain kit from the engine compartment. The kit includes (1) 12 ft. length of safety chain and (2) connecting links. Pull one end of the chain through the (2) key hole slots located in the front post of the mixer with a hook (see drawing below and decal on mixer front post). Attach the connecting links to each end of the chain. Follow the instructions in the TOWING section of this manual and on the mixer front post to attach the safety chain to the towing vehicle.

INSTALLING CHAIN TO MIXER

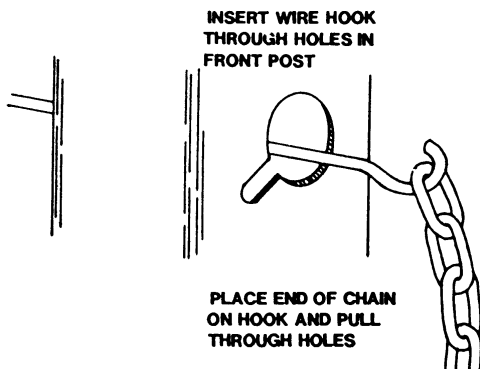

OIL LEVELS AND LUBRICATION - Be sure to check the oil levels in the engine and engine reduction unit BEFORE starting this unit. The engine warranty is **VOID** if it is run without oil. Consult the ENGINE MANUAL supplied with this unit for specific instructions and oil recommendations.

Also check the trunnion bearings to make sure they have been greased. Consult the Lubrication Section of the manual for the specific instructions if greasing is required.

! WARNING

BEFORE WORKING ON MACHINE, MAKE SURE ENGINE SPARK PLUG WIRE IS DISCONNECTED, OR, IF ELECTRIC, THAT THE ELECTRIC CORD IS DISCONNECTED, TO PREVENT ANY ACCIDENTAL STARTING.

HARDWARE

Check all hardware on mixer and engine / motor before starting. Consult the TORQUE CHART section of this manual and tighten any loose hardware accordingly.

FUEL

If your mixer is equipped with a gasoline engine, fill the gas tank with clean gasoline from a safety can. Consult the ENGINE MANUAL supplied with this unit for the proper type of gasoline required.

DO NOT mix oil with gasoline.

! WARNING

FOLLOW THE GUIDELINES FOUND IN THE SAFETY PRECAUTION SECTION OF THIS MANUAL WHENEVER HANDLING GASOLINE.

TO START THE ENGINE/MOTOR

COLD START - Open the fuel valve under the gas tank all the way. Open the throttle approximately half way and apply the choke. Pull the starter rope sharply about (3) times. When the engine starts, open the choke and adjust the throttle as necessary to keep it running. Allow the engine to warm up for a few minutes before placing it under the load. If the engine doesn't start after (3) pulls, open choke slightly to prevent flooding. Always operate the engine at full throttle when under load.

HOT START - Open the valve under the gas tank all the way if it has been shut off. Open the throttle approximately half way. Do not apply the choke. Pull the starter rope sharply until the engine starts. When

OPERATION

95CMP & 95CMPED

the engine starts, adjust the throttle. Always operate the engine at full throttle when under load. Adjust engine speed so drum is turning between 20 - 25 RPM.

NOTE: These starting instructions are general guidelines only. Since many engine Options are available on the manufacturer's CM mixers, consult the ENGINE MANUAL included with this unit for specific instructions.

ELECTRIC MOTORS - Use the proper size (3) wire (grounded) extension cord, conforming to the National Electric Code and Local Ordinances. DO NOT use (2) wire extension cord. Carefully check any extension cord which you plan on using for broken connectors, bare wires and damaged insulation. DO NOT use any cord found to be in poor condition. Make sure the extension cord is not routed through standing water and that all the connections are tight. Use the shortest extension cord possible. Turn motor on.

TO STOP THE ENGINE / MOTOR

GASOLINE ENGINES - Depress kill switch located on stationary cowl half and hold down until engine stops completely. Consult the ENGINE MANUAL included with this unit for specific instructions.

WARNING

IF THE MIXER IS TO BE LEFT UNATTENDED FOR ANY LENGTH OF TIME, CLOSE THE FUEL VALVE UNDER THE GAS TANK.

ELECTRIC MOTORS - TURN THE MOTOR OFF. IF THE MIXER IS TO BE LEFT UNATTENDED FOR ANY LENGTH OF TIME, DISCONNECT THE POWER CORD.

OPERATION

Start the engine / motor as instructed above and allow gasoline engines to reach operating temperatures. Close the engine cowl. NEVER operate the mixer with cowl open.

With drum operating between 20 - 25 RPM's the mixer is now ready for the addition of the concrete mix. For best results proceed as follows:

1. Pour the required amount of water into drum.
2. Add the required amount of gravel.
3. Add the required amount of cement.
4. Add the required amount of sand.

By adding the water and gravel first the drum will be kept clean and a good tumbling action will be added. To discharge concrete, grasp handwheel firmly with one hand and release tilt brake by pushing up on the tilt handle with the other, (see diagram below).

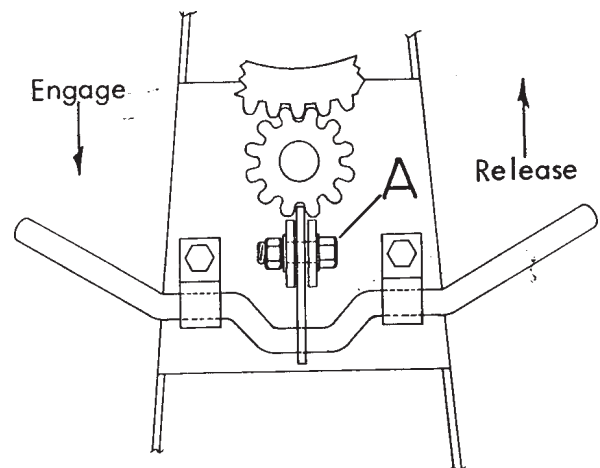

To prevent accidental discharge, never release brake without holding the handwheel firmly. Do not attempt to grab handwheel to stop an accidental discharge, serious injury could result. Always make sure that the brake is fully engaged after discharge of concrete and before reloading drum.

After discharge of concrete, immediately pour in the required amount of water for the next batch.

NOTE: When servicing brake mechanism, bolt A should be tightened so that approximately 17 - 18 pounds of force is required to release the brake. This will prevent accidental discharge due to vibration.

OPERATION

95CMP & 95CMPED

CAPACITIES

	95CMP	95CMPED
Total Drum Volume	15.1 cu. ft.	15.1 cu. ft.
Max. Batch Size*	9.0 cu. ft.	9.0 cu. ft.

* Maximum batch size depends on mix and type of aggregate used.

SAMPLE MIX

Volume relationship of 1:2-1/4:3 (cement : sand : gravel) mix. The mix volume may vary depending on aggregate used.

Mix Volume Cu. ft.	3	4	6	9
Cement Bags ^F	1/2	2/3	1	1-1/2
Water Gal. ^F	2-1/2	3-1/2	5-1/4	8
Sand Gal./shovels ^F	9	12	18	18
Gravel Gal./shovels ^F	12	16	23	23

CLEANING

For consistent performance, long life and continued high quality mixing of cement, thoroughly clean the mixer inside and out at the end of each day's operation. Drum may be scoured by 2 minute operation with gravel and water mixture. Discharge, then hose down drum inside and outside. Keep mixer clean.

Before cleaning, shut the engine or motor and disconnect the spark plug wire or electric cord to prevent accidental starting. Spray the mixer with water before the mix dries to remove any accumulations. Dried mix should be scraped out as necessary.



Recommended Coupler Maintenance Read Entire Owners Manual

1. Smear ball socket and clamp face with chassis grease. Periodically, oil pivot points and sliding surfaces of coupler with SAE 30 wt. motor oil.
2. When parking or storing your trailer, keep the coupler off the ground so dirt will not build up in the ball socket.
3. Replacement instructions:
 - Use (2) 1/2 inch grade 5 through bolts and locknuts, torque to 57 ft. lbs.

OPERATION

95CMP & 95CMPED

⚠ WARNING

NEVER POUR OR SPRAY WATER OVER THE ENGINE OR MOTOR.

NEVER PUT HANDS OR ANY OBJECT INTO THE DRUM WHILE THE ENGINE OR MOTOR IS RUNNING.

ALWAYS DISCONNECT THE SPARK PLUG WIRE OR ELECTRIC CORD WHEN CLEANING INSIDE DRUM.

TOWING

Before attempting to tow this mixer, check the state and local laws that apply to your intended route and check the following:

1. Hitch attached to the towing vehicle securely.
2. Towpole fully extended and bolted to mixer securely.
3. Safety chain hooked up properly (see illustration below or decal on mixer front post).

INSTALLING CHAIN TO VEHICLE

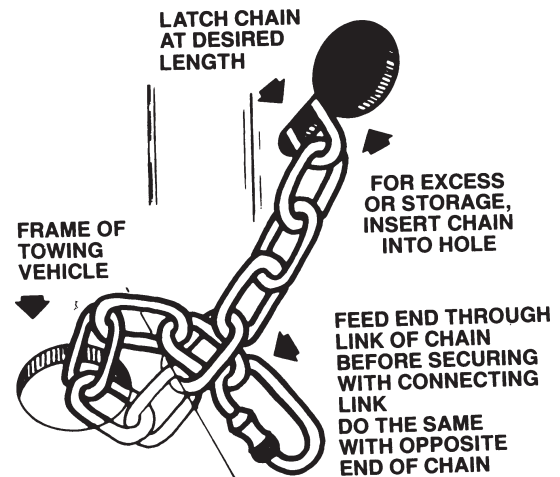

4. Lug nuts, wheel nuts and axle mount nuts tight.
5. Main axle springs and small snubber springs and bolts not broken or cracked.
6. Tires in good shape and at proper inflation as follows:

Tire size B78 x 13 @ 35 P.S.I. (95CMP & 95CMPED)

Refer to FRAME AND DRUM ASSEMBLY and AXLE ASSEMBLY sections of the Service/Parts Manual for parts identification and location.

⚠ WARNING

DO NOT EXCEED A TOWING SPEED OF 55 MILES/HR (90 KM/HR). FOR POOR ROAD CONDITIONS OR INCLEMENT WEATHER, REDUCE SPEED ACCORDINGLY.

MAINTENANCE

95CMP & 95CMPED

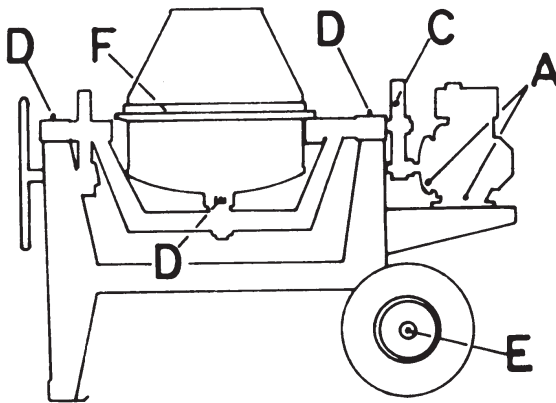

NOTE: Cowl removed for clarity. Do not operate mixer with cowl removed.

A. ENGINE - Daily check the oil levels in the engine and engine reduction unit. The engine warranty is **1 year** if run without oil. Since there are many options available on this mixer, consult the ENGINE MANUAL for specific recommendations as to oil level, oil type required and frequency of oil changes required. For maximum service life from the engine, follow those recommendations.

B. * WEEKLY - Grease idler shaft pillow block bearings on electric drive models.

WEEKLY - Check diesel gearbox oil level. Oil level should be visible at pipe plug. Lubricate diesel gearbox with SAE30W to SAE80W oil as needed.

C. WEEKLY - Lubricate chain and sprockets on chain drive models with a few drips of SAE 30 motor oil or any spray chain lube.

D. MONTHLY - Grease trunnions (2) places and drum spindle (2) places.

E. YEARLY - Repack (4) tapered roller bearings in wheel hubs and replace wheel seals. Install washer and nut. Torque to 20 ft. lbs. back off one turn, torque to 7 ft. lbs. back off to first slot in nut and insert cotter key.

F. DO NOT lubricate pinion and ring gear. They will collect abrasive materials and accelerate wear.

Lubricate diesel gearbox with SAE30W oil as needed.

Use any Grade #1 lithium base grease for the above applications.

* See Exploded Views with Parts Section of this manual for exact location.

* Gearbox gasket kit P/N 23197.

CALIFORNIA PROPOSITION 65 WARNING: Engine exhaust from this product contains chemicals known to the State of California to cause cancer, birth defects, or other reproductive harm.



***Bred Tough. Technology Born to Work.
The Way It Ought To Be.***

Stone Construction Equipment, Inc.
P.O. Box 150, Honeoye, New York 14471
Phone: (800) 888-9926
Fax: 585-229-2363
e-mail: sceny@stone-equip.com
www: stone-equip.com

A 100% employee-owned American manufacturer

© 1994 Stone Construction Equipment, Inc.
Printed in U.S.A.