

**SOUTHERN-TOOL**

**1-800-458-3687**

**FAX: 1-865-675-8296**

**NEW STANDARD MOLDING KNIVES**

W&H supplies just about any molding knives you need. We ship most off-the-shelf knives within 48hours—faster, if you're in a jam. The standard patterns shown in our style sheet are the most often used—and they're normally in stock. Need special knives? Just send us an accurate tracing or a sample of the molding you wish to duplicate—we'll grind the knives for you! The workmanship will be superb, with quick delivery.

All knives are made from the *finest quality High Speed Steel* for long run production requirements.

If molding requires knives for top and bottom cuts, please specify by ordering: 1 set each top and bottom.

---

**STANDARD PATTERNS**

---

<b>EDP NO.</b>	<b>PART NO.</b>
10173	8575
10172	CR890-T
10174	CR897-T
10175	CR897-B
10176	BC400
10177	BC500
10178	CR894-T
10179	CR894-B
10180	CR895-T
10181	CR895-B
10182	CR899-T
10183	CR899-B
10184	C444
10185	SH100
10186	C350
10187	C355
10188	C356
10189	B2500
10190	CR898-T
10191	CR898-B
10192	8018-T
10193	8018-B
10194	CR896-T
10195	CR896-B
10196	C99
10197	BR100
10198	AS100
10199	BR300
10200	AS200

---

Call 1-800-458-3687  
For Pricing

Payment in advance is required for all special knives, no COD orders are accepted.  
Orders for special knives may not be cancelled or returned for credit.

15

CR897T

CROWN TOP

$3 \frac{5}{8} \times \frac{3}{4}$

BC400

BASE CAP

$\frac{3}{4} \times 1 \frac{3}{8}$

CR897B

CROWN BOTTOM

$3 \frac{5}{8} \times \frac{3}{4}$

BC500

BASE CAP

$\frac{5}{8} \times \frac{3}{4}$

CR894T

CROWN TOP

$2 \frac{3}{4} \times \frac{3}{4}$

CR894B

CROWN BOTTOM

$2 \frac{3}{4} \times \frac{3}{4}$

①6

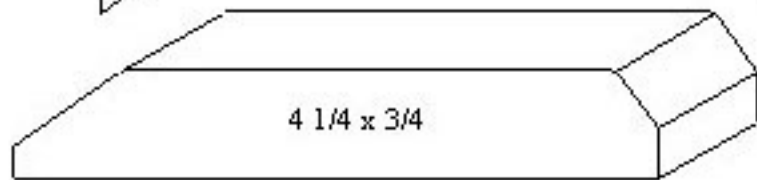
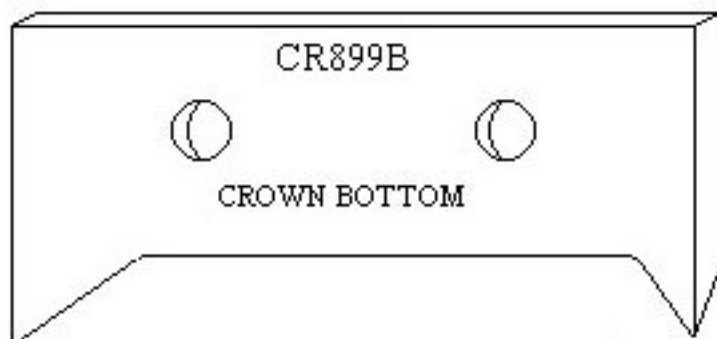
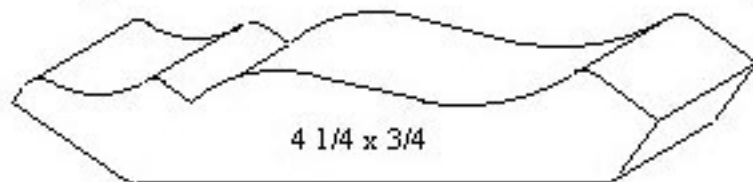
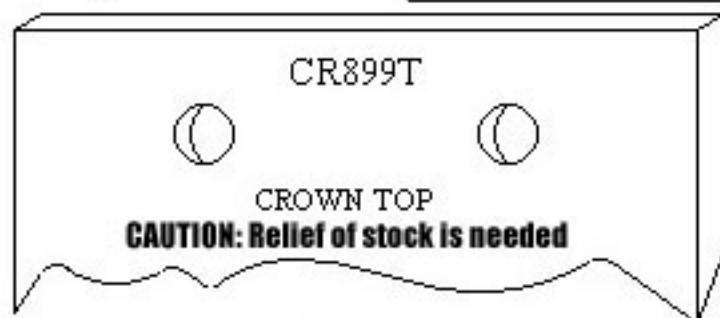
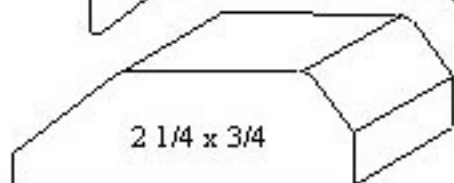
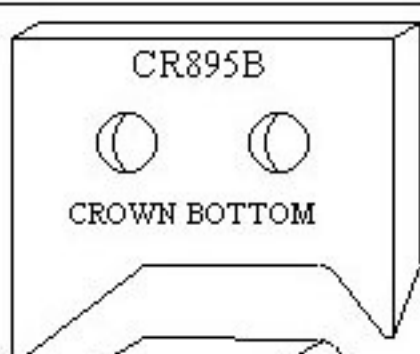
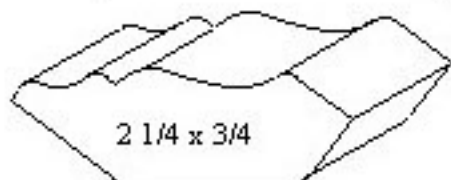
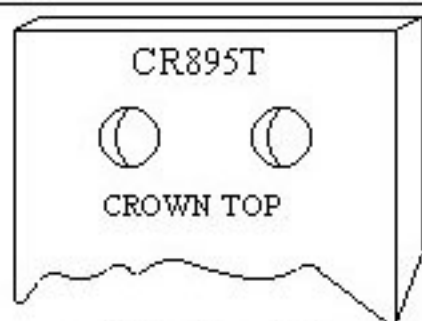

17

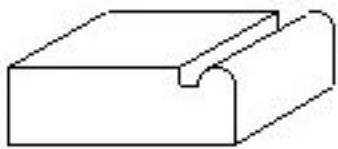
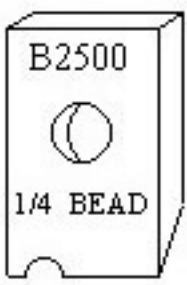
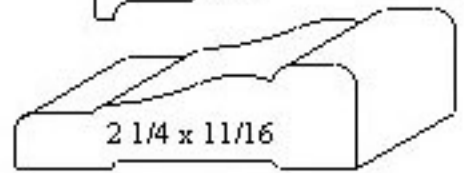
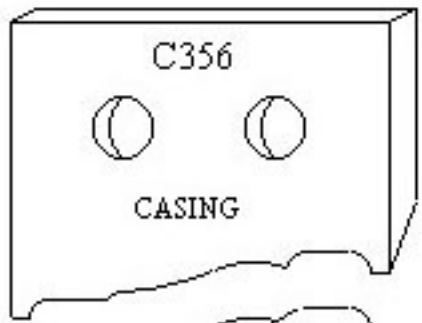
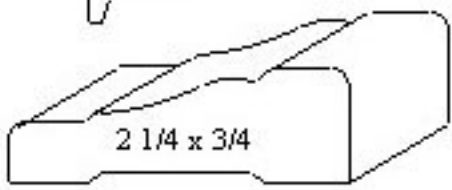
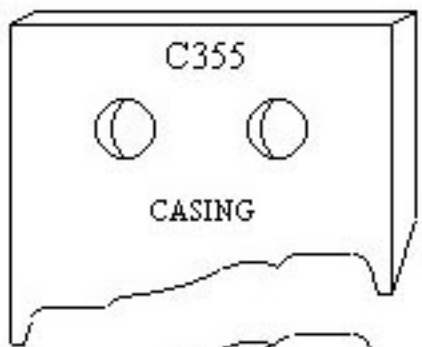
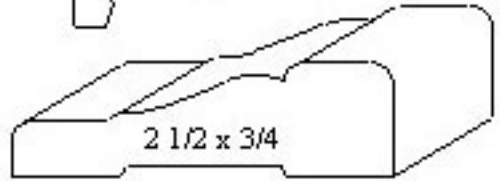
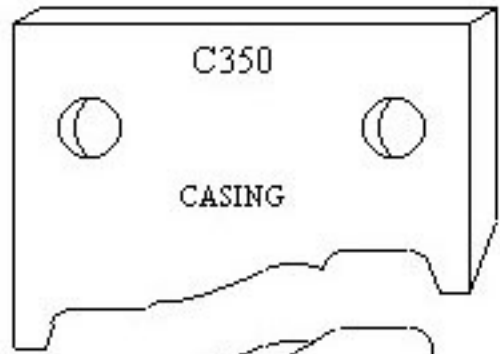
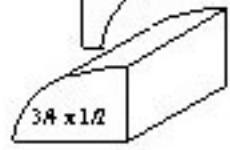
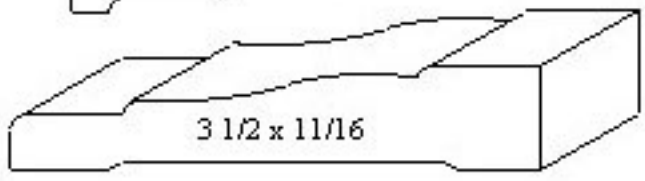

18

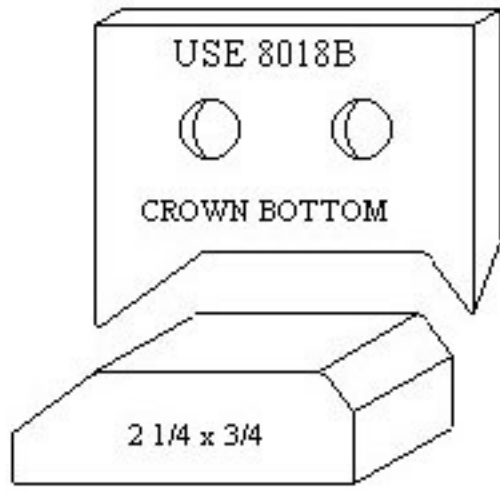
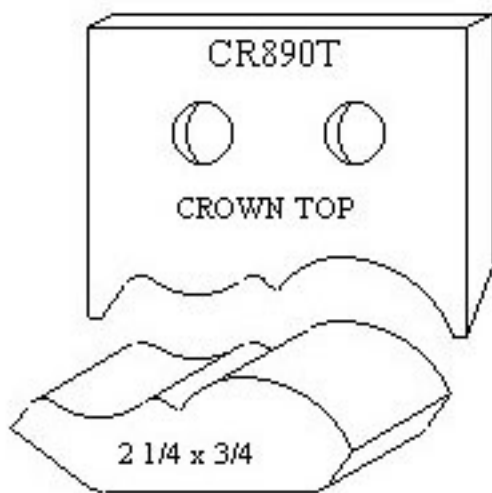
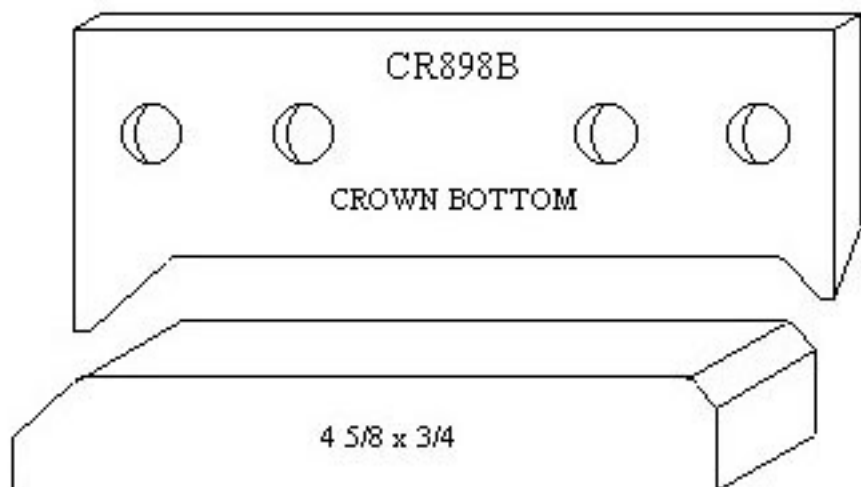
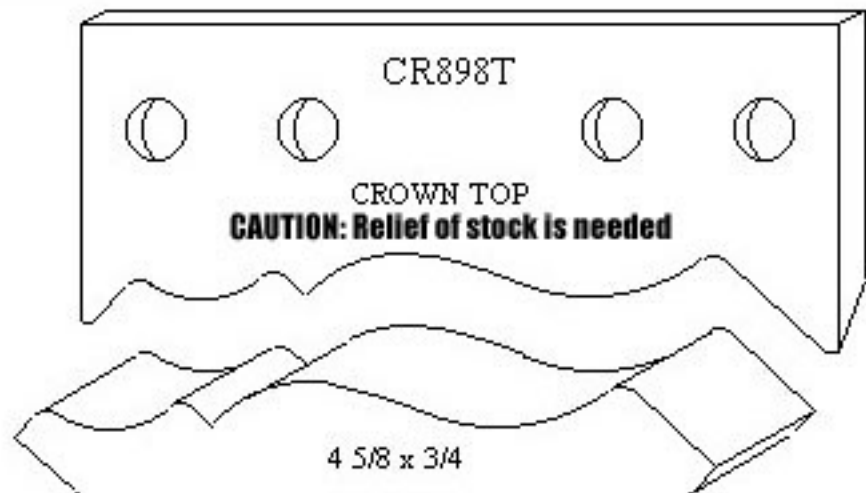

19

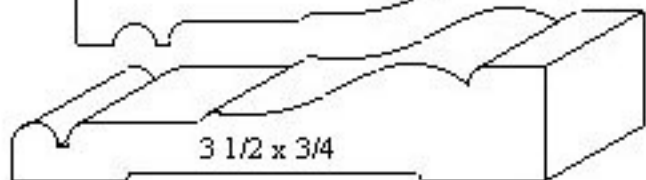
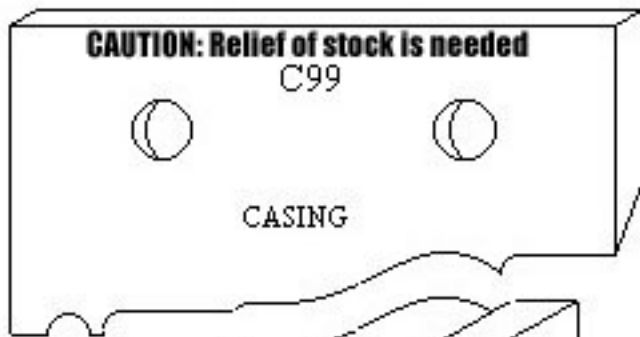
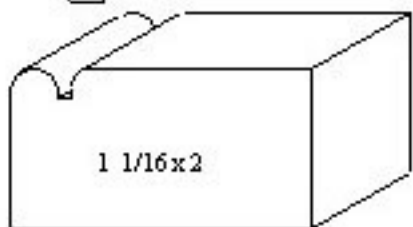
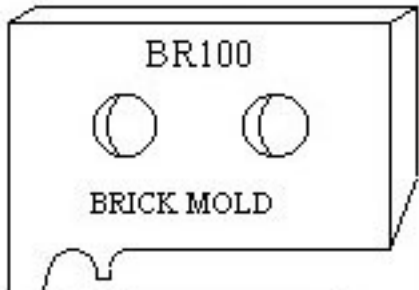
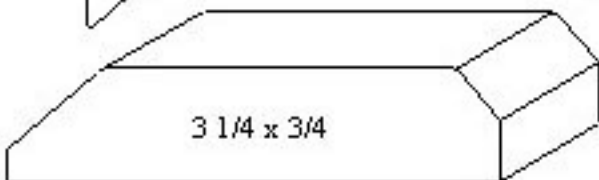
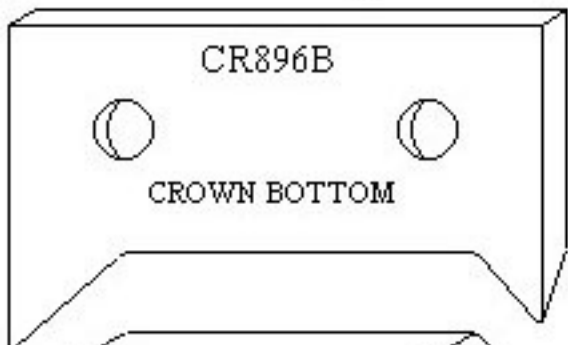
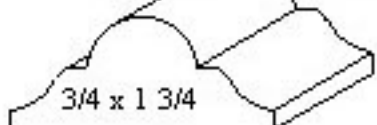
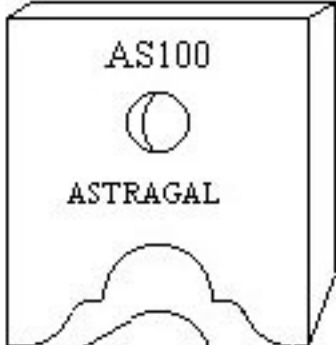
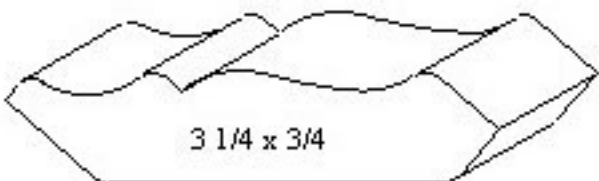
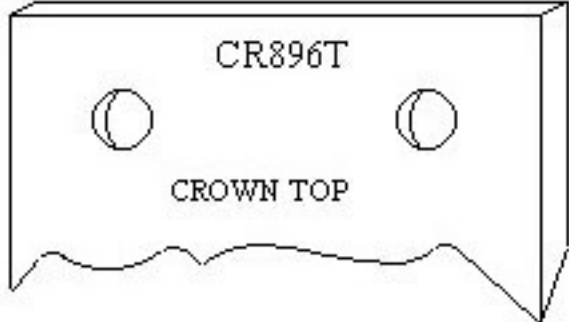

20

