

INTAKE VIEW

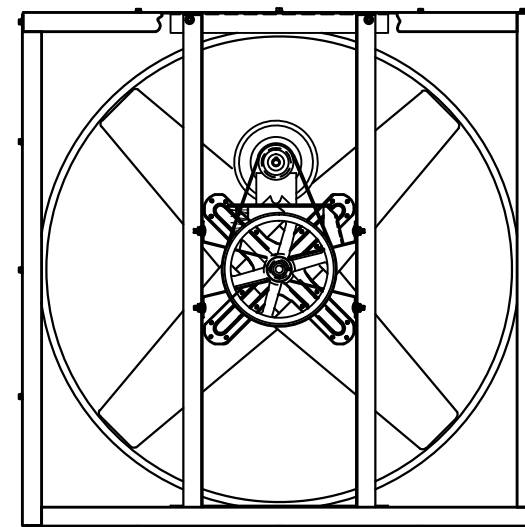

DISCHARGE VIEW

HORSE POWER: 3/4  
 VOLTAGE: 230/460V  
 PHASE: 3  
 BLADE DIAMETER: 36"

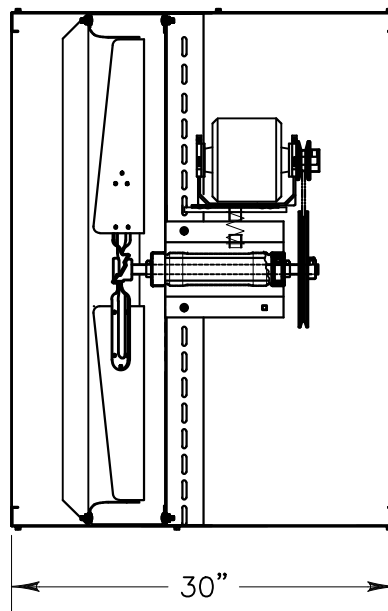

TRIANGLE ENGINEERING  
 OF ARKANSAS, INC.

RVI3614X  
 WALL FAN

RVI3614X

REV

DR. BY: TOM KING

CKD.

APP.

SHEET 1 OF 1

NOT TO SCALE

28 SEP 2015