

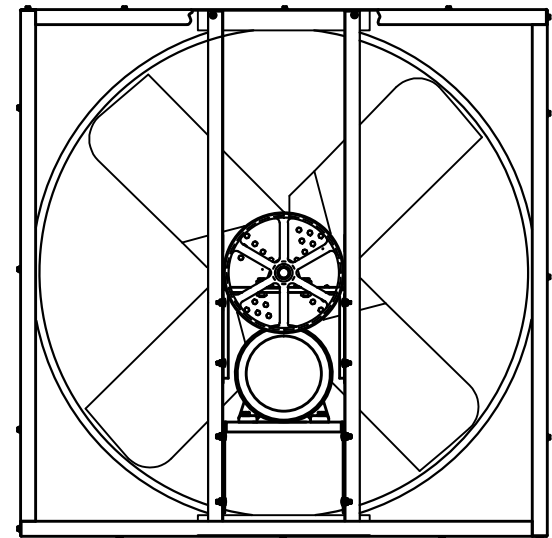

INTAKE VIEW

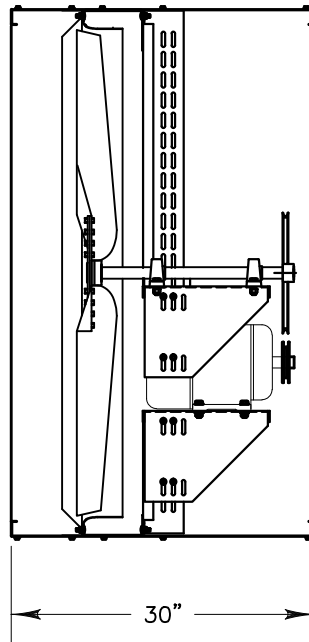

DISCHARGE VIEW

HORSE POWER: 2  
 VOLTAGE: 115/230V  
 PHASE: 1  
 BLADE DIAMETER: 54"

 TRIANGLE ENGINEERING OF ARKANSAS, INC.	RVI5417U WALL FAN	
	RVI5417U	REV
DR. BY: TOM KING	CKD.	APP.
SHEET 1 OF 1	NOT TO SCALE	7 OCT 2015