

INTAKE VIEW

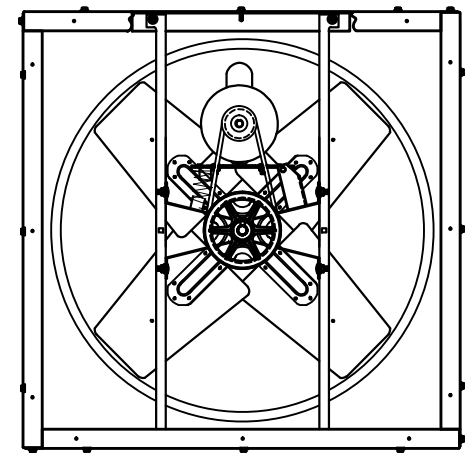

DISCHARGE VIEW

HORSE POWER: 3/4
 VOLTAGE: 230/460V
 PHASE: 3
 BLADE DIAMETER: 30"

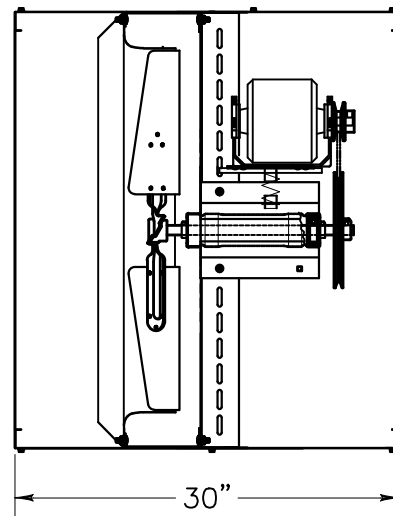

TRIANGLE ENGINEERING
 OF ARKANSAS, INC.

RVI 3014X
 WALL FAN

RVI3014X

REV

DR. BY: TOM KING

CKD.

APP.

SHEET 1 OF 1

NOT TO SCALE

1 OCT 2015