

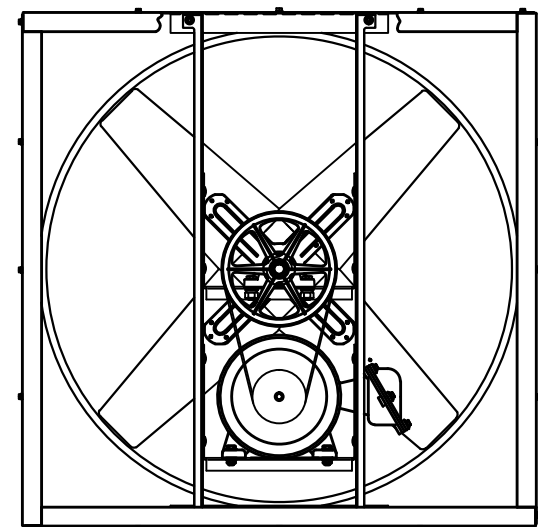

INTAKE VIEW

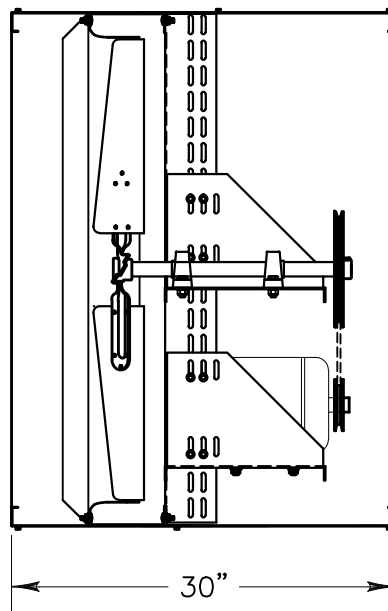

DISCHARGE VIEW

HORSE POWER: 2
 VOLTAGE: 230/460V
 PHASE: 3
 BLADE DIAMETER: 36"

 TRIANGLE ENGINEERING OF ARKANSAS, INC.	RVI3617X WALL FAN	
	RVI3617X	REV
DR. BY: TOM KING	CKD.	APP.
SHEET 1 OF 1	NOT TO SCALE	28 SEP 2015