

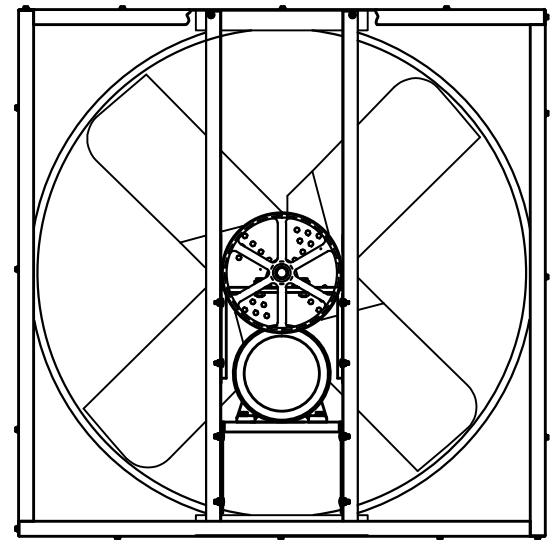

INTAKE VIEW

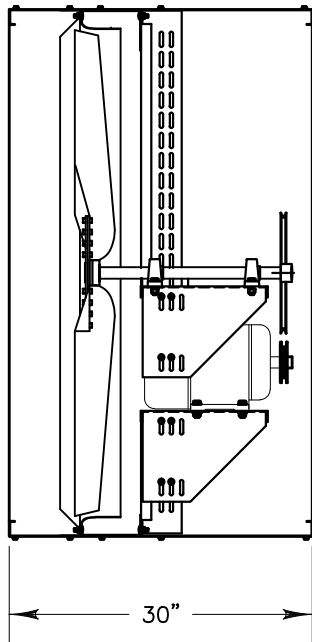

DISCHARGE VIEW

HORSE POWER: 5  
 VOLTAGE: 230/460V  
 PHASE: 3  
 BLADE DIAMETER: 48"

 TRIANGLE ENGINEERING OF ARKANSAS, INC.	RVI4819X WALL FAN	
	RVI4819X	REV
DR. BY: TOM KING	CKD.	APP.
SHEET 1 OF 1	NOT TO SCALE	6 OCT 2015