

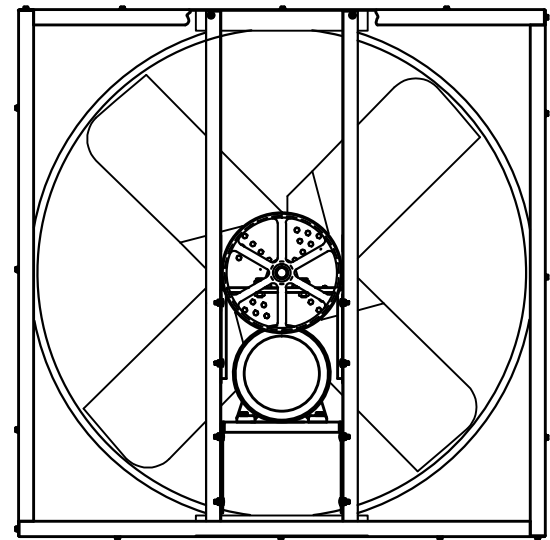

INTAKE VIEW

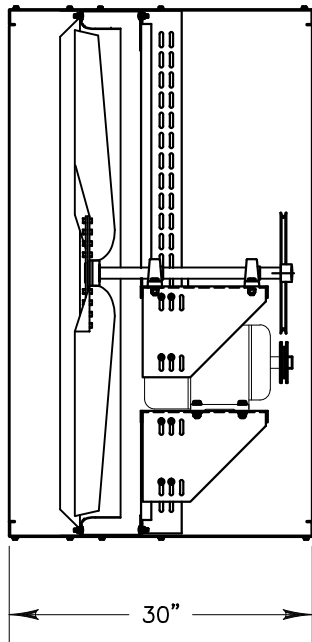

DISCHARGE VIEW

HORSE POWER: 3
 VOLTAGE: 115/230V
 PHASE: 1
 BLADE DIAMETER: 54"

 TRIANGLE ENGINEERING OF ARKANSAS, INC.	RVI5418U WALL FAN	
	RVI5418U	REV
DR. BY: TOM KING	CKD.	APP.
SHEET 1 OF 1	NOT TO SCALE	7 OCT 2015