

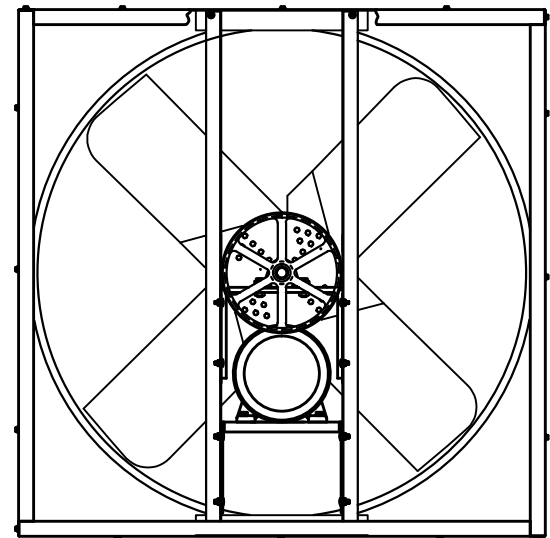

INTAKE VIEW

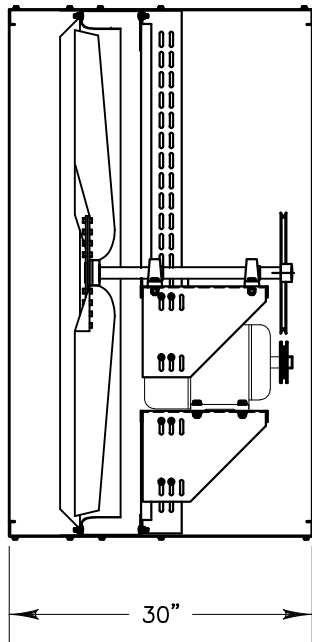

DISCHARGE VIEW

HORSE POWER: 2
 VOLTAGE: 115/230V
 PHASE: 1
 BLADE DIAMETER: 60"

 TRIANGLE ENGINEERING OF ARKANSAS, INC.	RVI6017U WALL FAN	
	RVI6017U	REV
DR. BY: TOM KING	CKD.	APP.
SHEET 1 OF 1	NOT TO SCALE	7 OCT 2015