

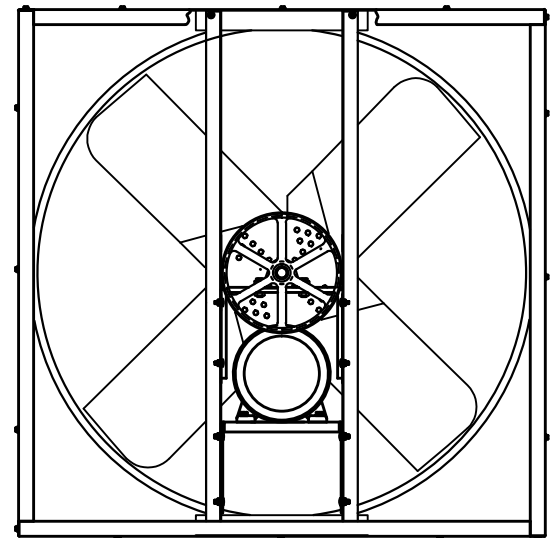

INTAKE VIEW

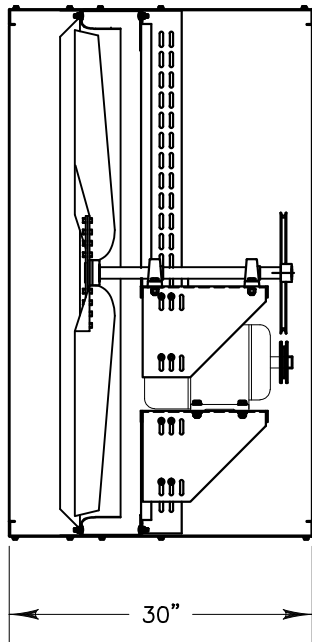

DISCHARGE VIEW

HORSE POWER: 5
 VOLTAGE: 230/460V
 PHASE: 3
 BLADE DIAMETER: 60"

 TRIANGLE ENGINEERING OF ARKANSAS, INC.	RVI6019X WALL FAN	
	RVI6019X	REV
DR. BY: TOM KING	CKD.	APP.
SHEET 1 OF 1	NOT TO SCALE	7 OCT 2015