

DISCHARGE VIEW

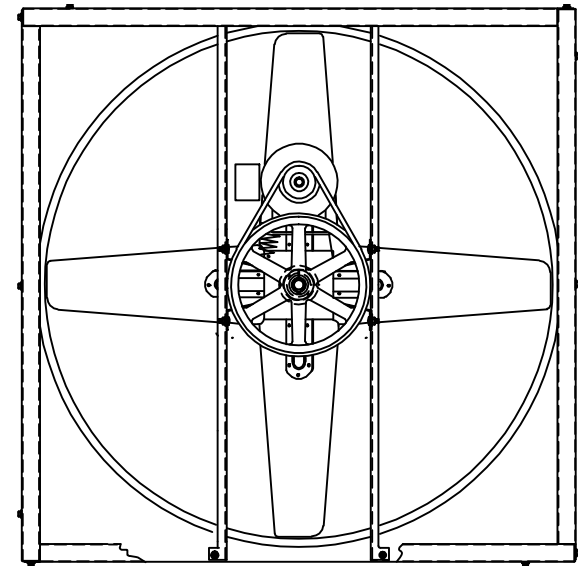
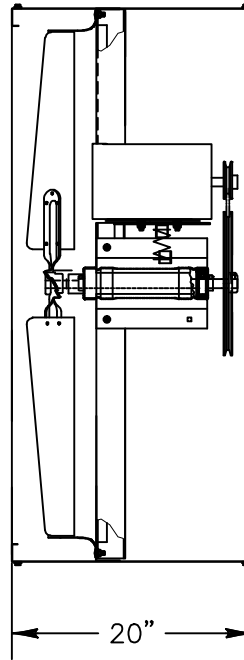

INTAKE VIEW

TRIANGLE ENGINEERING
CERTIFIED DRAWING

BY:
FOR:
DATE:
VI4816 WALL FAN, 1 1/2 HP
230/460 V. 3 PHASE
BLADE DIA 48"



TRIANGLE ENGINEERING
OF ARKANSAS, INC.

VI4816
WALL FAN

L-VI4816

REV

DR. BY: TOM KING

CKD.

APP.

SHEET 1 OF 1

NOT TO SCALE

12 DEC 2003